

GENERAL DESCRIPTION

The EV1593DN-00A is the Evaluation Board for MPS' MP1593 Step-Down DC/DC Converter. It features a wide supply range of 4.75V to 28V and a continuous output current up to 3A. The output voltage is set to 3.3V, but can be easily adjusted to other levels from 1.22V. A 385KHz high switching frequency allows the use of small, low cost capacitors and inductors. Current mode control and an integrated power MOSFET minimize component count, board area, and solution cost. Fault condition protection includes cycle-by-cycle current limiting, thermal shutdown, and under-voltage lockout. Internal soft-start reduces the turn-on stress. The small but thermally enhanced 8-pin SOIC package minimizes board area and provides excellent thermal management.

ELECTRICAL SPECIFICATION

Parameter	Symbol	Value	Units
Supply Voltage	V_{IN}	4.75 – 28	V
Output Voltage	V_{OUT}	3.3	V
Output Current	I_{OUT}	0 – 3	A

FEATURES

- Up to 3A Output Current
- Wide 4.75 to 28V Operating Input Range
- Monolithic Buck with 100mΩ Internal FET
- Fixed 385KHz Frequency
- All Ceramic Input and Output Capacitors
- Programmable Soft-Start
- Programmable Input Under-Voltage Lockout

APPLICATIONS

- Distributed Power Systems
- Battery Charger
- Pre-Regulator for Linear Regulators

MPS, "MPS", "Monolithic Power Systems", and "The Future of Analog IC Technology" are Registered Trademarks of Monolithic Power Systems, Inc.

EV1593DN-00A EVALUATION BOARD

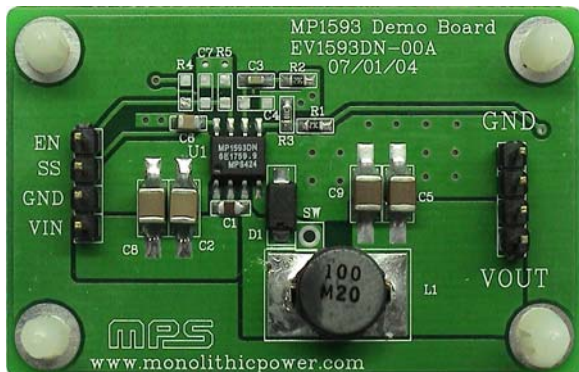

(2.1"X x 1.3"Y x 0.4"Z)

Board Number	MPS IC Number
EV1593DN-00A	MP1593

Efficiency vs Load Current

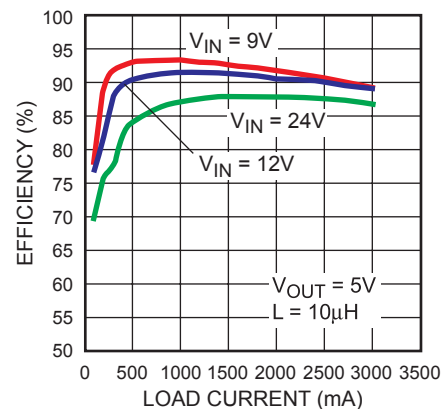

EV1593_TAC_EC01

EVALUATION BOARD SCHEMATIC

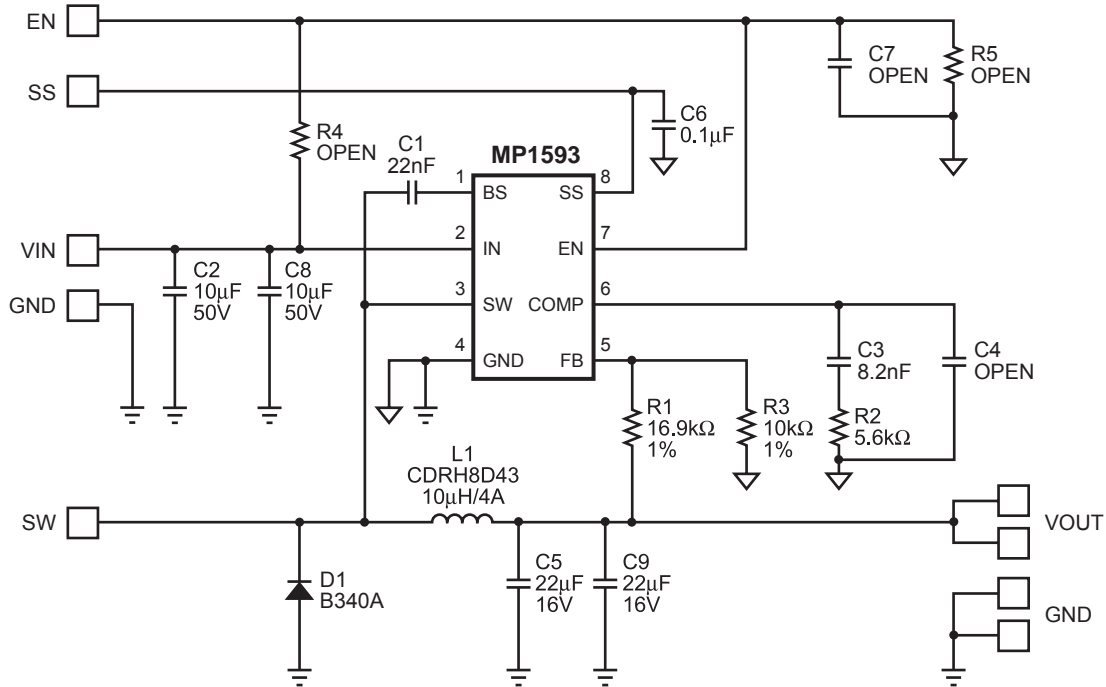

EV1593_S01

EV1593DN-00A BILL OF MATERIALS

Qty	Ref	Description	Package	Manufacturer	Part Number
1	C1	Ceramic Capacitor, 22nF, 50V, X7R	0805	Any	
2	C2, C8	Ceramic Capacitor, 10µF, 50V, Y5V	1210	Murata	GRM32DF51H106ZA01L
1	C3	Ceramic Capacitor, 8.2nF, 50V, X7R	0603	Any	
0	C4, C7	Open			
2	C5, C9	Ceramic Capacitor, 22µF, 16V, X5R	1210	Taiyo Yuden	EMK3Z5BJ226MM
1	C6	Ceramic Capacitor, 0.1µF, 50V, X7R	0805	Any	
1	L1	Inductor, 10µH, 4A		Sumida	CDRH8D43-100NC
0	D1	Schottky Diode, 40V, 3A	SMA	Diodes Inc.	B340A
1	U1	28V, 3A, Step Down Converter	SOIC8	MPS	MP1593DN
1	R1	Resistor, 16.9kΩ, 1%	0603	Any	
1	R2	Resistor, 5.6kΩ, 5%	0603	Any	
1	R3	Resistor, 10kΩ, 1%	0603	Any	
0	R4	Open			
0	R5	Open			

TYPICAL PERFORMANCE CHARACTERISTICS

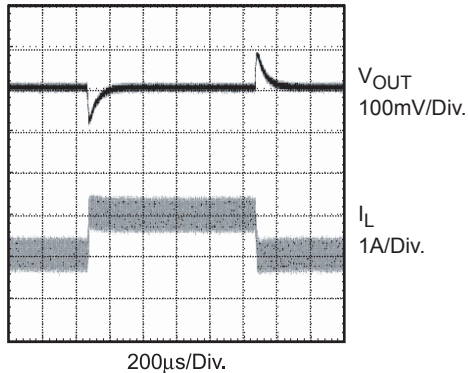
Load Transient Waveforms

200 μ s/Div.
 $V_{IN} = 12V, V_{OUT} = 3.3V, 1A - 2A$ STEP

EV1593-WF01

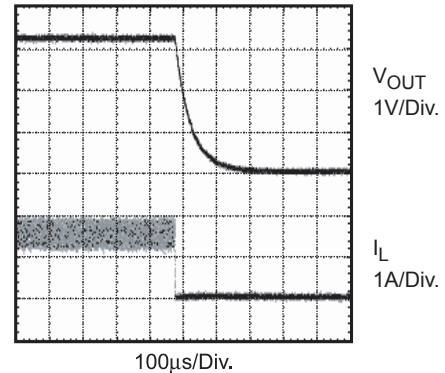
Turn Off Waveforms

100 μ s/Div.
 $V_{IN} = 12V, V_{OUT} = 3.3V, R_{LOAD} = 2\Omega$

EV1593-WF02

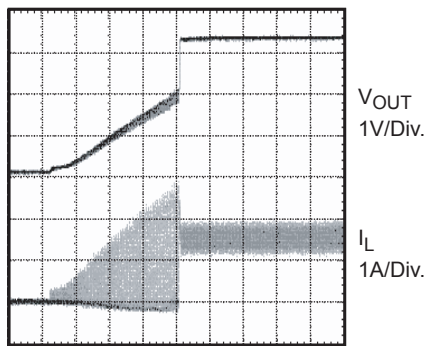
Soft-Start Waveforms

4ms/Div.
 $V_{IN} = 12V, V_{OUT} = 3.3V, R_{LOAD} = 2\Omega$

EV1593-WF03

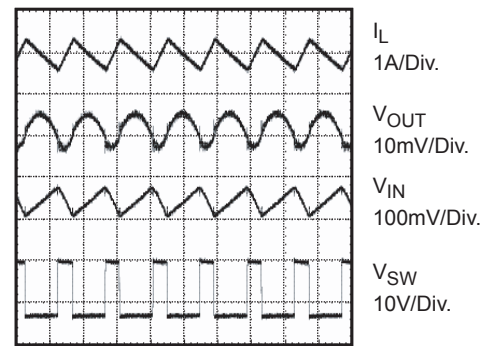
Switching Waveforms

2 μ s/Div.
 $V_{IN} = 12V, V_{OUT} = 3.3V, R_{LOAD} = 2\Omega$

EV1593-WF04

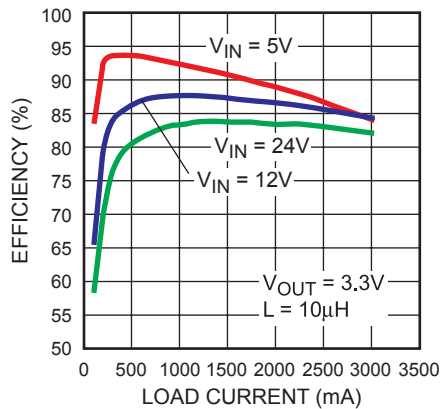
Efficiency vs Load Current

EV1593_TPC05

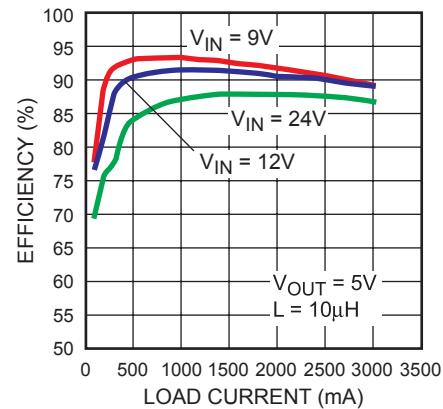
Efficiency vs Load Current

EV1593_TPC06

PRINTED CIRCUIT BOARD LAYOUT

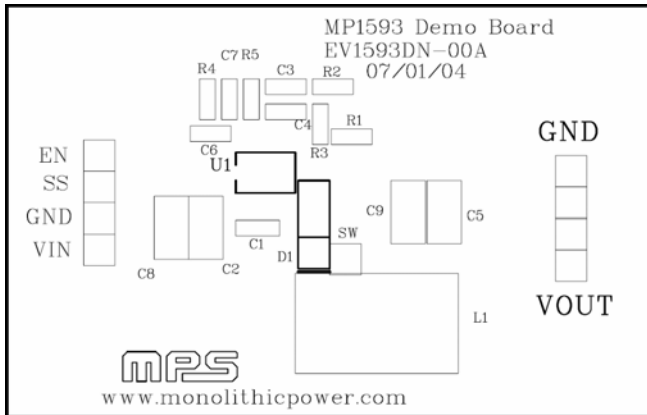

Figure 1—Top Silk Layer

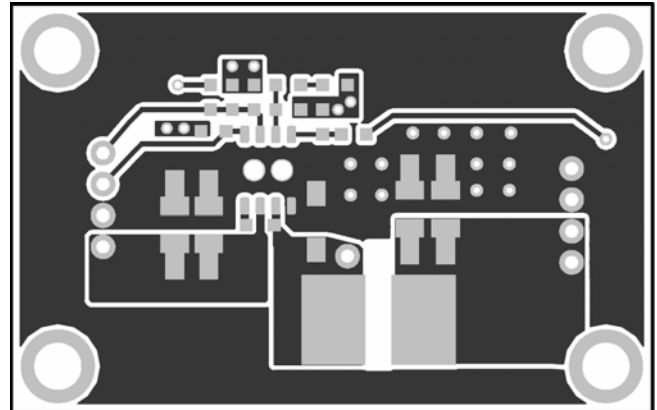

Figure 2—Top Layer

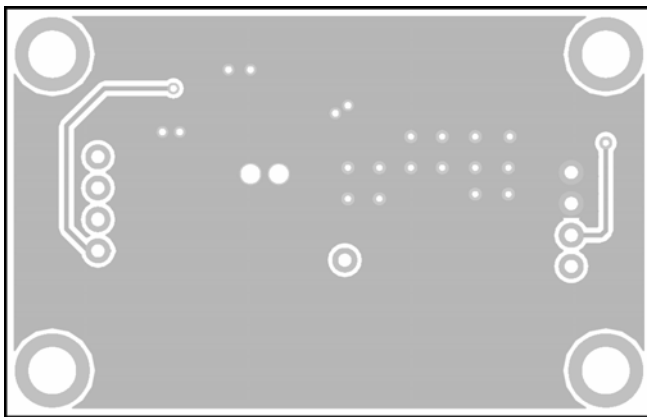

Figure 3— Bottom Layer

QUICK START GUIDE

1. Connect the positive terminal of the load to VOUT pins, and the negative terminal of the load to GND pins
2. Preset the power supply output to 4.75V – 28V and turn off the power supply.
3. Connect the positive terminal of the power supply output to the VIN pin and the negative terminal of the power supply output to the GND pin
4. Turn the power supply on. The MP1593 will automatically startup.
5. To use the Enable function, apply a digital input to EN pin. Drive EN higher than 2.5V to turn on the regulator, drive EN less than 0.7V to turn it off.
6. An input under voltage lockout (UVLO) function can be implemented by the addition of a resistor divider R4 and R5.

The EN threshold is 2.5V, so V_{IN} UVLO threshold is $\left(1 + \frac{R4}{R5}\right) \times 2.5V$.

RECOMMENDED COMPONENTS FOR STANDARD OUTPUT VOLTAGES

The output voltage of this board is set to 3.3V. This board is laid out to accommodate most commonly used inductors and output capacitors and to be programmed for most standard output voltages. The following table lists recommended components for some standard output voltages.

Listed compensation components (R2, C3) values are based on the output capacitor installed on this board. For other capacitors, refer to the Application Information section in the MP1593 datasheet.

Table 1—Recommended Components for Standard Output Voltages

VOUT	R1	R2	C3	L1
1.8V	4.75kΩ	3kΩ	4.7nF	4.7μH
2.5V	10.5kΩ	3.9kΩ	5.6nF	4.7-6.8μH
3.3V	16.9kΩ	5.6kΩ	8.2nF	6.8-10μH
5V	30.9kΩ	7.5kΩ	10nF	10-15μH
12V	88.7kΩ	10kΩ	3.3nF	15-22μH

NOTICE: MPS believes the information in this document to be accurate and reliable. However, it is subject to change without notice. Contact MPS for current specifications. MPS encourages users of its products to ensure that third party Intellectual Property rights are not infringed upon when integrating MPS products into any application. MPS cannot assume any legal responsibility for any said applications.