

TO-92 Encapsulate Three Terminal Voltage Regulators

CJ78L09 Three-terminal positive voltage regulator

FEATURES

Maximum Output current

I_{OM} : 0.1 A

Output voltage

V_o : 9 V

Continuous total dissipation

P_D : 0.625 W

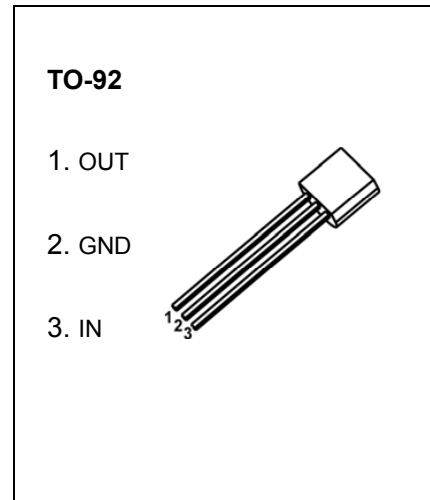

ABSOLUTE MAXIMUM RATINGS (Operating temperature range applies unless otherwise specified)

Parameter	Symbol	Value	Unit
Input Voltage	V_i	30	V
Operating Junction Temperature Range	T_{OPR}	0~+150	°C
Storage Temperature Range	T_{STG}	-55 ~ +150	°C

ELECTRICAL CHARACTERISTICS AT SPECIFIED VIRTUAL JUNCTION TEMPERATURE ($V_i=16V, I_o=40mA, C_i=0.33\mu F, C_o=0.1\mu F$, unless otherwise specified)

Parameter	Symbol	Test conditions	Min	Typ	Max	Unit	
Output voltage	V_o	25°C	8.64	9.0	9.36	V	
		0-125°C	$12V \leq V_i \leq 24V, I_o=1mA-40mA$	8.55	9.0	9.45	V
			$I_o=1mA-70mA$	8.55	9.0	9.45	V
Load Regulation	ΔV_o	$I_o=1mA-100mA$	25°C	19	90	mV	
		$I_o=1mA-40mA$	25°C	11	40	mV	
Line regulation	ΔV_o	$12V \leq V_i \leq 24V$	25°C	45	175	mV	
		$13V \leq V_i \leq 24V$	25°C	40	125	mV	
Quiescent Current	I_q		25°C	4.1	6.0	mA	
Quiescent Current Change	ΔI_q	$13V \leq V_i \leq 24V$	0-125°C		1.5	mA	
	ΔI_q	$1mA \leq I_o \leq 40mA$	0-125°C		0.1	mA	
Output Noise Voltage	V_N	$10Hz \leq f \leq 100KHz$	25°C	58		μV	
Ripple Rejection	RR	$15V \leq V_i \leq 25V, f=120Hz$	0-125°C	45		dB	
Dropout Voltage	V_d		25°C	1.7		V	

TYPICAL APPLICATION

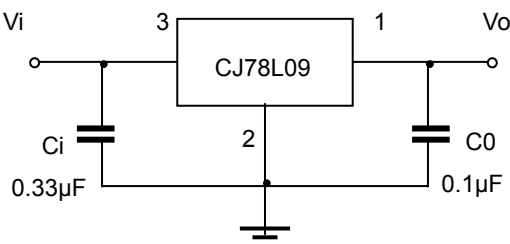

Note : Bypass capacitors are recommended for optimum stability and transient response and should be located as close as possible to the regulators.

Output Characteristics

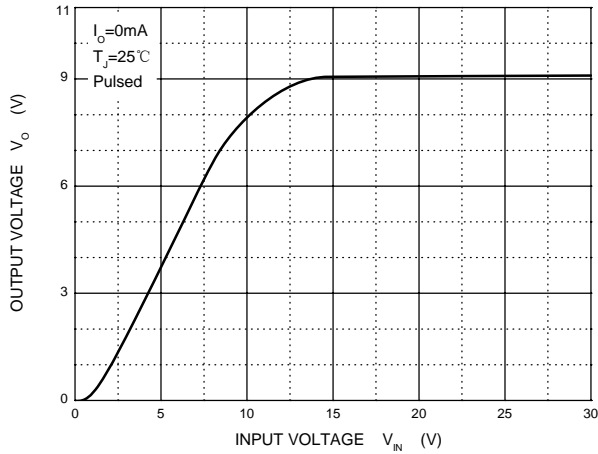

Dropout Characteristics

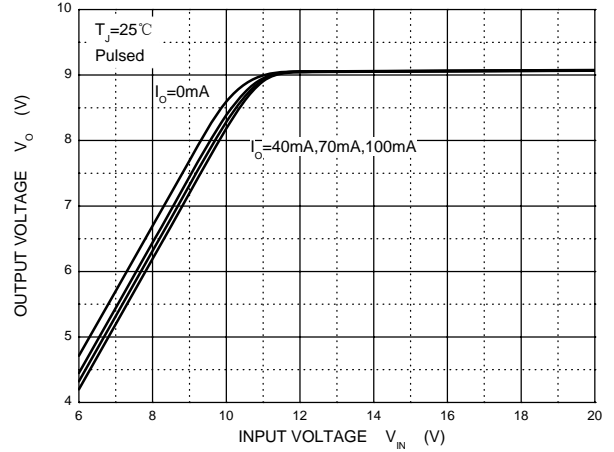

Quiescent Current vs Input Voltage

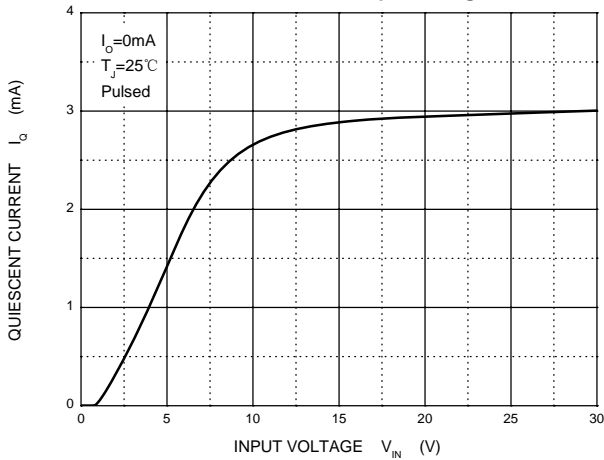

Quiescent Current vs Output Current

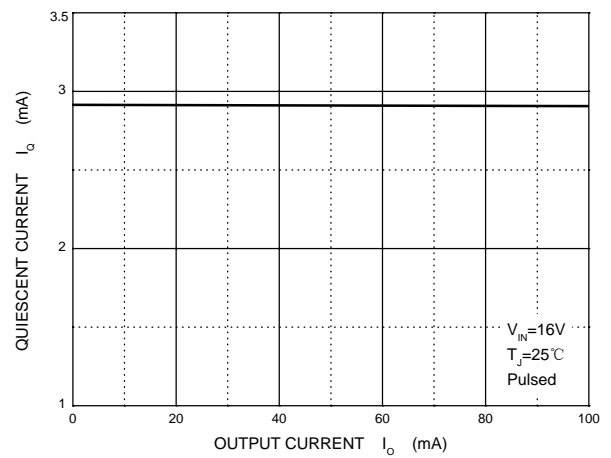

Output Voltage vs Ambient Temperature

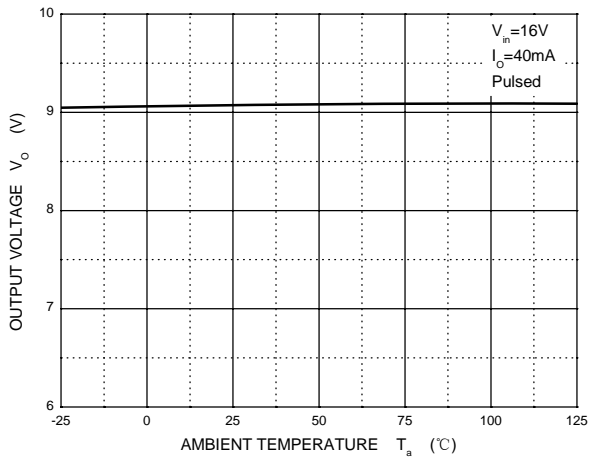

Current Cut-off Grid Voltage

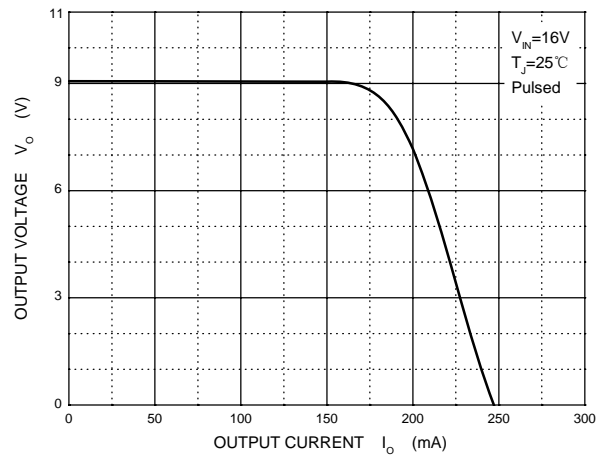

Power Derating Curve

